

# Performance Analysis of the Shell-And-Tube Heat Exchangers with Various Design Aspects

Nilesh kumar kushwaha<sup>1</sup>, Prof vishwajeet kureel<sup>2</sup>

<sup>1</sup> Research scholar, Department of Mechanical Engg, GRKIST Jabalpur (M.P.)

<sup>2</sup> Asst. Prof., Department of Mechanical Engg, GRKIST Jabalpur (M.P.)

**Abstract-** The parameters considered for the study for thermo-hydraulic performance comparison Pressure drop, temperature difference, heat transfer coefficient and heat flux using LMTD analysis. The numerical results indicate that the pressure drop shows a big difference among the three patterns and is maximum for Triangular Pattern, the overall heat transfer coefficient is higher for rotated square pattern design, turbulent kinetic energy is maximum for the square pattern tube arrangement helps to create a turbulence flow of a fluid which in turn increases the heat transfer efficiency and for high difference in between hot and cold fluid inlet temperature rotated square pattern tube arrangement shows high heat flux, while at lower difference it is almost same for square and rotated square pattern tube arrangement.

**Index Terms-** Shell and tube heat exchanger, Square Pattern tube, Rotated Square pattern tube Triangular pattern tube, LMTD.

## I. INTRODUCTION

### 1.1 Heat Exchanger

A heat exchanger is a contraption that is used to exchange thermal energy (enthalpy) between no less than two liquids, between a strong surface and a fluid, or between strong particulates and a fluid at various temperatures and in thermal contact. In heat exchangers, there are typically no outer heat and work cooperations. Commonplace applications include heating or cooling of a liquid stream of concern and vanishing or buildup of single-or multicomponent liquid streams. In different applications, the goal might be to recuperate or dismiss heat, or sterilize, sanitize, fractionate, distil, think, take shape, or control a procedure liquid. In a couple of heat exchangers, the fluids trading heat are in coordinate contact.

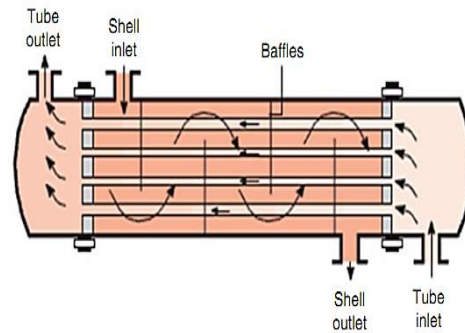

Figure 1.1 A shell-and-tube heat exchanger; one shell pass and one tube pass

## II- LITERATURE REVIEW

Different analysts have been examine the plan and dimensional investigation in shell and tube heat exchangers. Some of them are

One of the worries with respect to these heat exchangers is to upgrade the heat transfer and enhance their productivity. Different analysts and researcher did there think about concerning it. The overview and explores had been completed in a huge way to enhance the heat transfer improvements. Some of them are as “*Arithmetic Mean Temperature Difference and the Concept of Heat Exchanger Efficiency*”, by Ahmad Fakheri, *Proceedings of HT2003, ASME Summer Heat Transfer Conference, July 21-23, 2003, Las Vegas, Nevada, USA*

In this paper, it is demonstrated that the Arithmetic Mean Temperature Difference, which is the distinction between the normal temperatures of hot and chilly fluids, can be utilized rather than the Log Mean Temperature Difference (LMTD) in heat exchanger investigation. For a given estimation of AMTD, there exists an ideal heat transfer rate,  $Q_{opt}$ , given by the result of  $UA$  and AMTD with the end goal that the rate of heat transfer in the heat

exchanger is constantly not as much as this ideal esteem.

*“Heat Exchanger Efficiency” by Ahmad Fakheri, Article in Journal of Heat Transfer · September 2007, DOI: 10.1115/1.2739620*

This paper gives the answer for the issue of characterizing thermal proficiency for heat exchangers in view of the second law of thermodynamics. It is demonstrated that relating to each genuine heat exchanger, there is a perfect heat exchanger that is an adjusted counter-stream heat exchanger.

### III-RESEARCH METHODOLOGY

#### 3.1 General

This chapter contains the research methodology adopted for the study. The chapter comprises two parts i.e. theoretical and CFD analysis.

#### 3.2 Theoretical Background

##### 3.2.1 Logarithmic Mean Temperature Difference (LMTD)

The driving force for any heat transfer process is a temperature contrast. For heat exchangers, there are two fluids required, with the temperatures of both changing as they go through the heat exchanger, so some type of normal temperature distinction is required.

##### The Effectiveness–NTU Method

The log mean temperature contrast (LMTD) technique talked about is anything but difficult to use in heat exchanger investigation when the delta and the outlet temperatures of the hot and chilly fluids are known or can be resolved from an energy adjust. When  $[\Delta T]_{\text{mean}}$ , the mass stream rates, and the general heat transfer coefficient are accessible, the heat transfer surface zone of the heat exchanger can be resolved

#### 3.3 Computerized Fluid Dynamics

Realistic flow field simulations in fluid flow applications need large computer memory and CPU time.

##### Mesh Generation

Once a mathematical model is selected, we can start with the major process of a simulation, namely the discretization process.

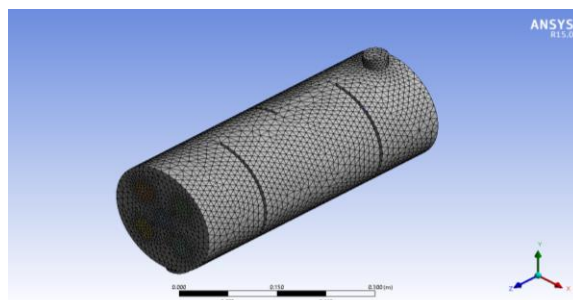

Figure 3.1 Mesh Generated

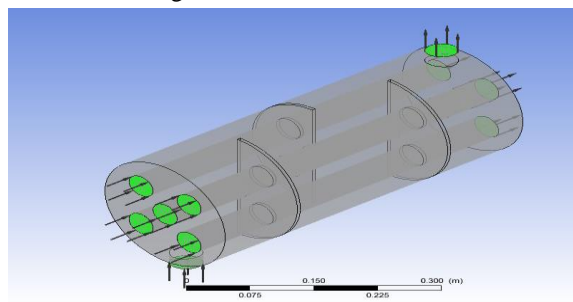

Figure 3.2 Boundary Condition

#### 3.3.4 Geometry Adopted

The aim of the study is to make a comparative analysis for the three different types of tube arrangement. The three different tube arrangement considered for the study are Square, Rotated square and triangular arrangement. The tube arrangement consider for the study is shown in figure 3.3.

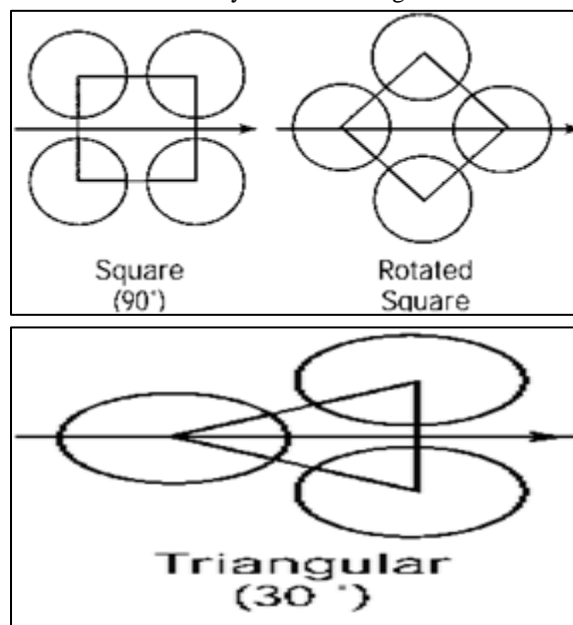

Figure 3.3 Tube Arrangement consider for the study

### IV-RESULT ANALYSIS

4.1 General

This chapter comprises the results obtained after the simulation process. The following results have been obtained:

4.1 Results for Square Pattern Tube Arrangement

The analysis has been carried out by varying the hot fluid inlet temperature from 318K to 348K with the difference of 10K while the cold fluid inlet temperature kept constant at 298K.

4.1.1 Hot Fluid Inlet Temperature 348K for Square Pattern Tube Arrangement

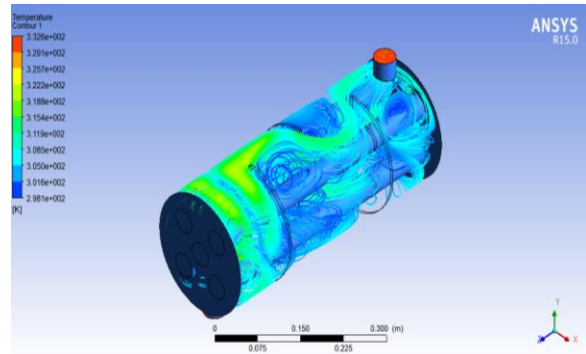

Figure 4.1(a) Temperature distribution for Hot water outlet and cold-water inlet temperature.

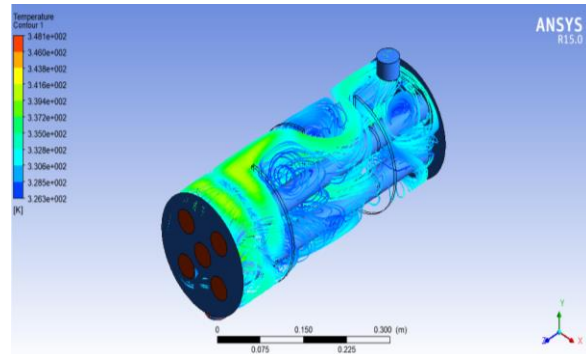

Figure 4.1(b) Temperature distribution for Hot water inlet and cold-water outlet temperature.

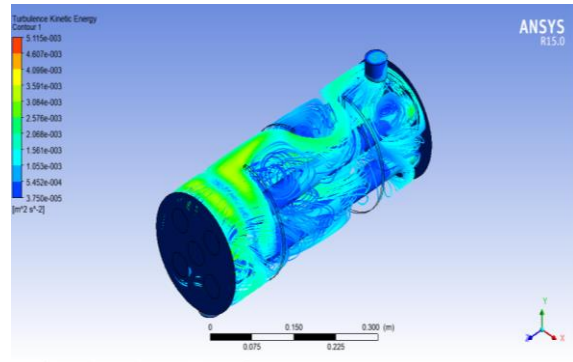

Figure 4.2 Turbulent Kinetic Energy Distribution for Square Pattern Tube Arrangement at 348 K Hot Fluid Inlet Temperature

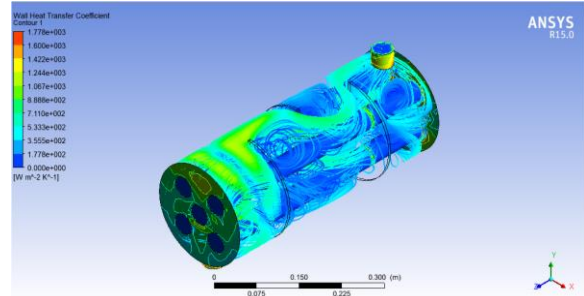

Figure 4.3 Wall Heat Transfer Coefficient Distribution for Square Pattern Tube Arrangement at 348 K Hot Fluid Inlet Temperature

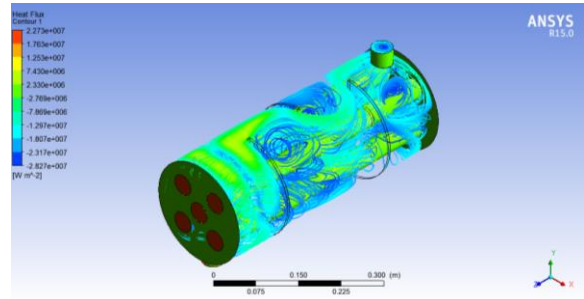

Figure 4.4 Heat Flux Distribution for Square Pattern Tube Arrangement at 348 K Hot Fluid Inlet Temperature

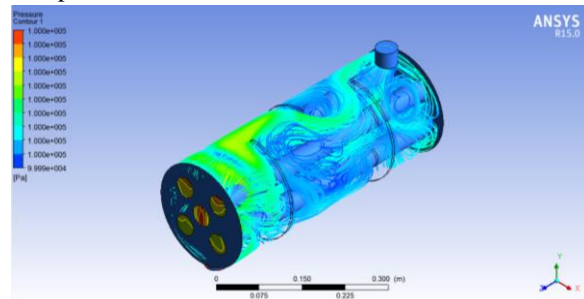

Figure 4.5 (a) Pressure distribution for Hot water outlet and inlet pressure.

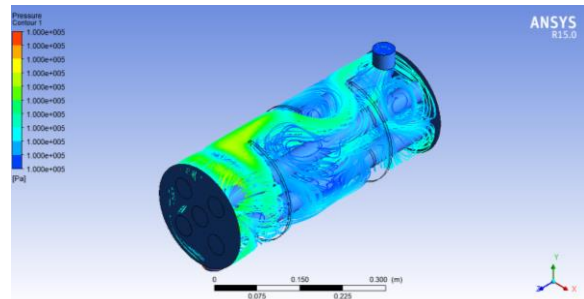

Figure 4.5 (b) Pressure distribution for Cold water inlet and outlet temperature.

Figure 4.5 (a) and (b) shows the Pressure distribution for Hot water outlet and inlet, cold water inlet and outlet pressure respectively.

4.1.2 Hot Fluid Inlet Temperature 338K for Square Pattern Tube Arrangement

Figure 4.6 (a) and (b) shows the Temperature distribution for Hot water outlet and cold-water inlet temperature and Temperature distribution for Hot water inlet and cold-water outlet temperature respectively.

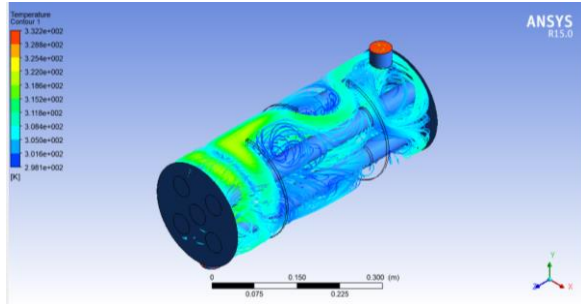

Figure 4.6 (a) Temperature distribution for Hot water outlet and cold water inlet temperature.

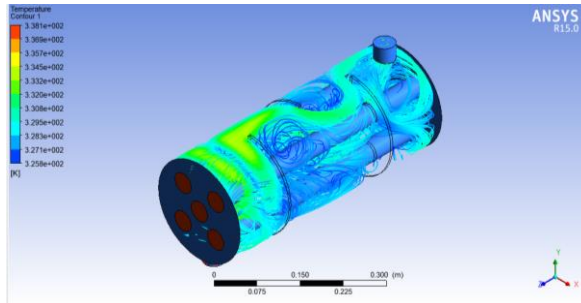

Figure 4.6 (b) Temperature distribution for Hot water inlet and cold water outlet temperature.

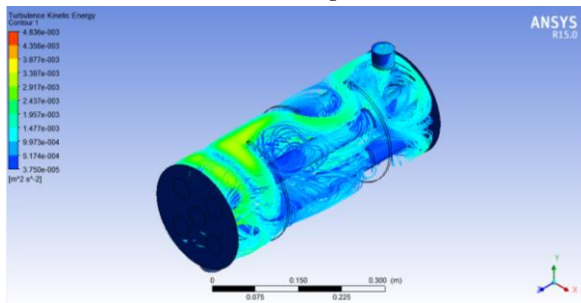

Figure 4.7 Turbulent Kinetic Energy Distribution for Square Pattern Tube Arrangement at 338 K Hot Fluid Inlet Temperature

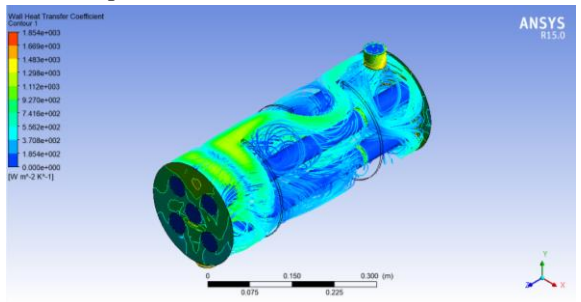

Figure 4.8 Wall Heat Transfer Coefficient Distribution for Square Pattern Tube Arrangement at 338 K Hot Fluid Inlet Temperature

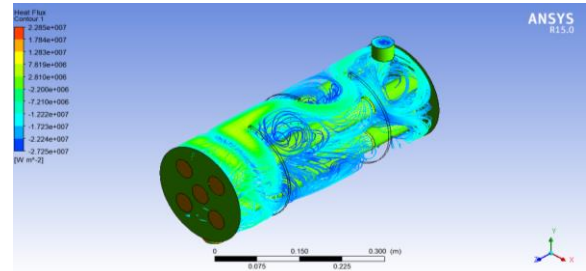

Figure 4.9 Heat Flux Distribution for Square Pattern Tube Arrangement at 348 K Hot Fluid Inlet Temperature

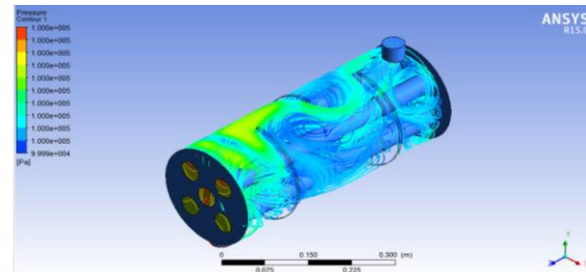

Figure 4.10 (a) Pressure distribution for Hot water outlet and inlet pressure.

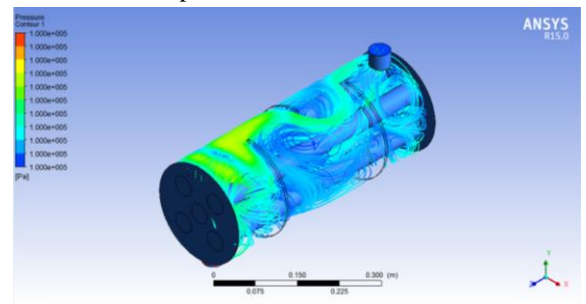

Figure 4.10 (b) Pressure distribution for Cold water inlet and outlet temperature.

Figure 4.10 (a) and (b) shows the Pressure distribution for Hot water outlet and inlet, cold water inlet and outlet pressure respectively.

4.1.3 Hot Fluid Inlet Temperature 328K for Square Pattern Tube Arrangement

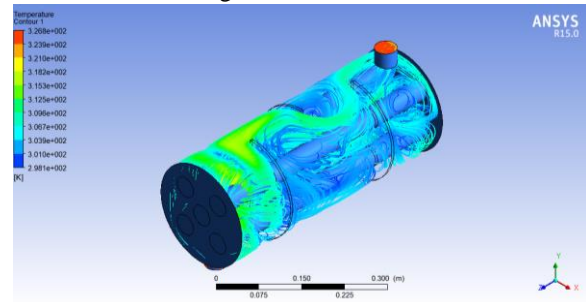

Figure 4.11 (a) Temperature distribution for Hot water outlet and cold-water inlet temperature.

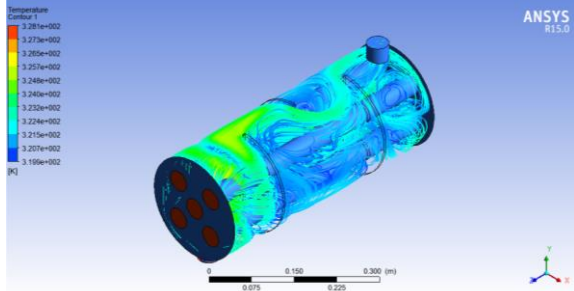

Figure 4.11 (b) Temperature distribution for Hot water inlet and cold-water outlet temperature.

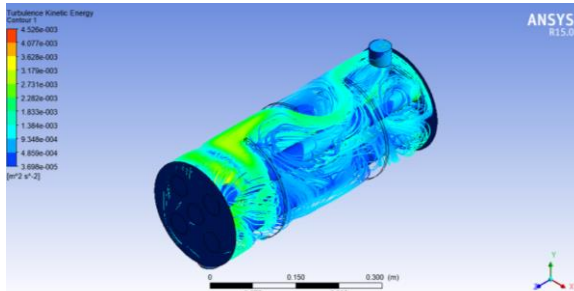

Figure 4.12 Turbulent Kinetic Energy Distribution for Square Pattern Tube Arrangement at 328 K Hot Fluid Inlet Temperature

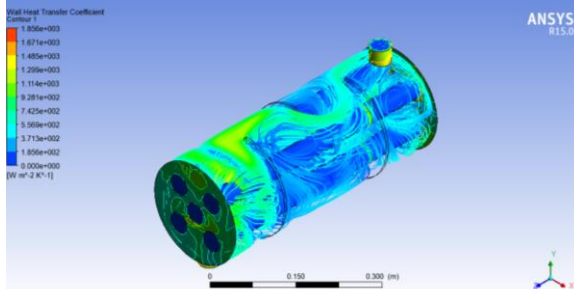

Figure 4.13 Wall Heat Transfer Coefficient Distribution for Square Pattern Tube Arrangement at 328 K Hot Fluid Inlet Temperature

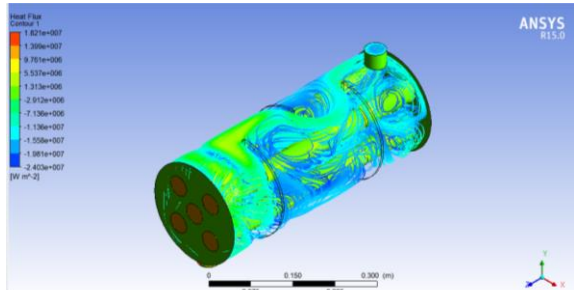

Figure 4.14 Heat Flux Distribution for Square Pattern Tube Arrangement at 328 K Hot Fluid Inlet Temperature

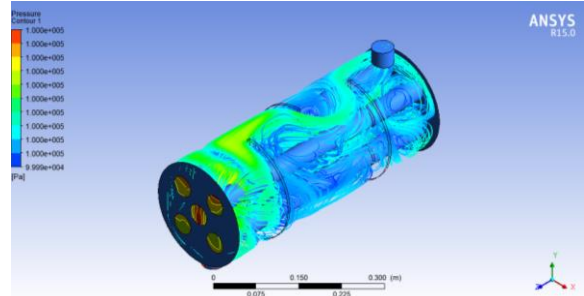

Figure 4.15 (a) Pressure distribution for Hot water outlet and inlet pressure.

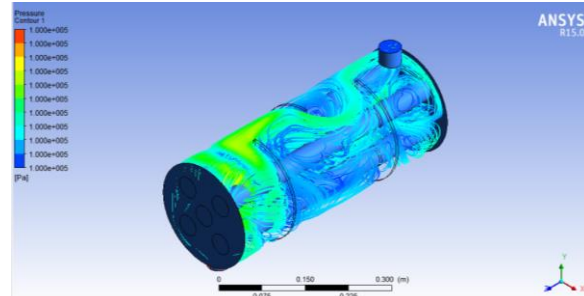

Figure 4.15 (b) Pressure distribution for Cold water inlet and outlet temperature.

## 4.2 Results for Rotated Square Pattern Tube Arrangement

### 4.2.1 Hot Fluid Inlet Temperature 348K for Rotated Square Pattern Tube Arrangement

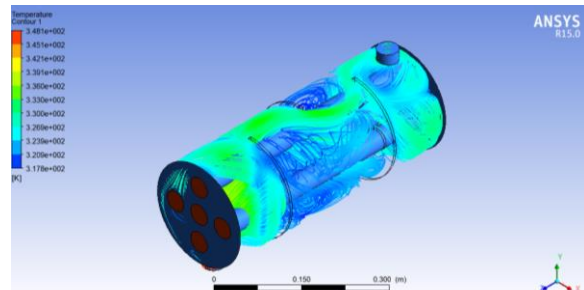

Figure 4.16(a) Temperature distribution for Hot water outlet and cold-water inlet temperature.

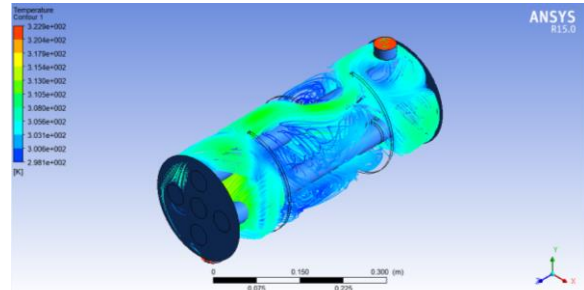

Figure 4.16(b) Temperature distribution for Hot water inlet and cold-water outlet temperature.

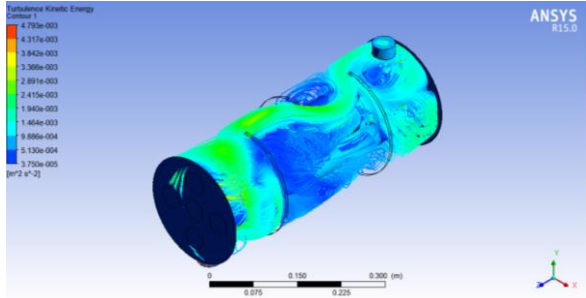

Figure 4.17 Turbulent Kinetic Energy Distribution for Rotated Square Pattern Tube Arrangement at 348 K Hot Fluid Inlet Temperature

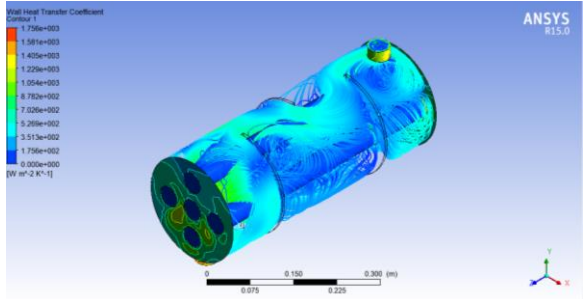

Figure 4.18 Wall Heat Transfer Coefficient Distribution for Rotated Square Pattern Tube Arrangement at 348 K Hot Fluid Inlet Temperature

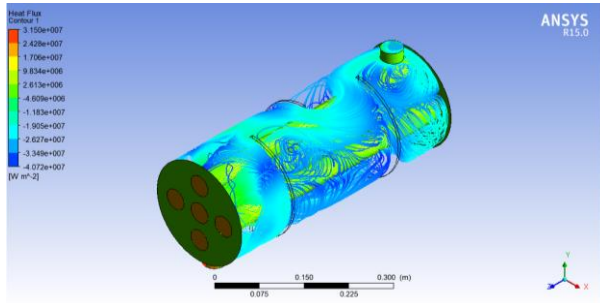

Figure 4.19 Heat Flux Distribution for Square Pattern Tube Arrangement at 348 K Hot Fluid Inlet Temperature

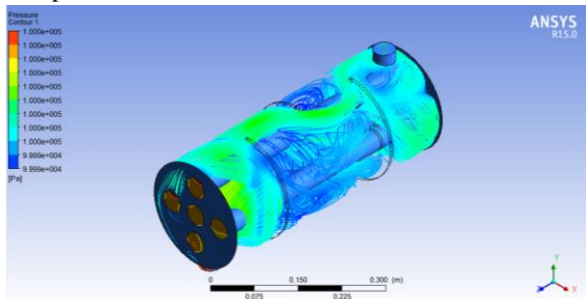

Figure 4.20 (a) Pressure distribution for Hot water outlet and inlet pressure.

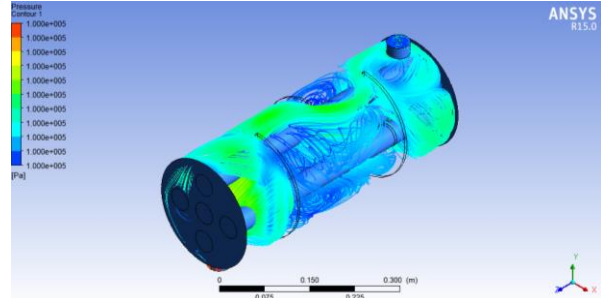

Figure 4.20 (b) Pressure distribution for Cold water inlet and outlet temperature.

4.2.2 Hot Fluid Inlet Temperature 338K for Rotated Square Pattern Tube Arrangement

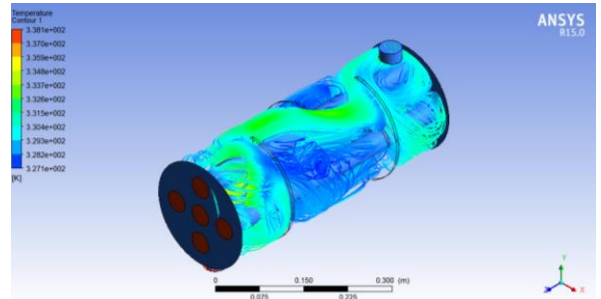

Figure 4.21 (a) Temperature distribution for Hot water outlet and cold-water inlet temperature.

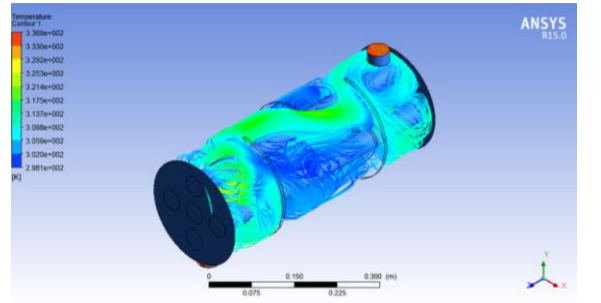

Figure 4.21 (b) Temperature distribution for Hot water inlet and cold-water outlet temperature.

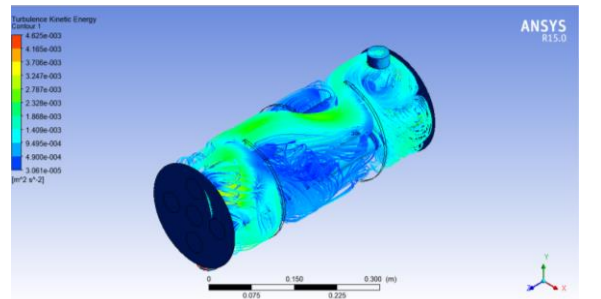

Figure 4.22 Turbulent Kinetic Energy Distribution for Rotated Square Pattern Tube Arrangement at 338 K Hot Fluid Inlet Temperature

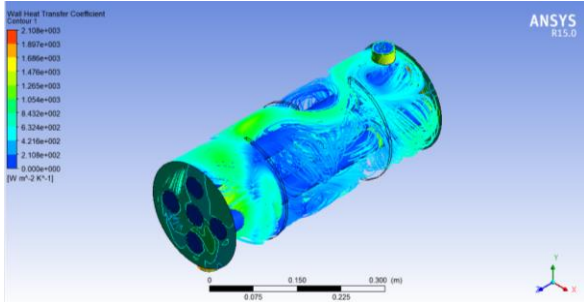

Figure 4.23 Wall Heat Transfer Coefficient Distribution for Rotated Square Pattern Tube Arrangement at 338 K Hot Fluid Inlet Temperature

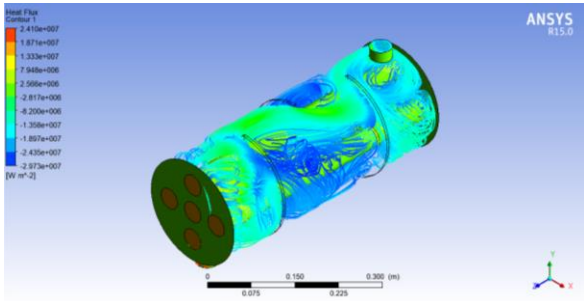

Figure 4.24 Heat Flux Distribution for Rotated Square Pattern Tube Arrangement at 348 K Hot Fluid Inlet Temperature

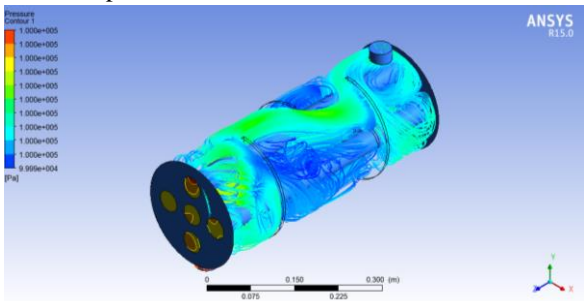

Figure 4.25 (a) Pressure distribution for Hot water outlet and inlet pressure.

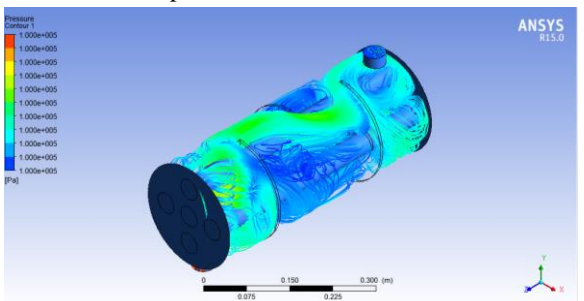

Figure 4.25 (b) Pressure distribution for Cold water inlet and outlet temperature.

4.2.3 Hot Fluid Inlet Temperature 328K for Rotated Square Pattern Tube Arrangement

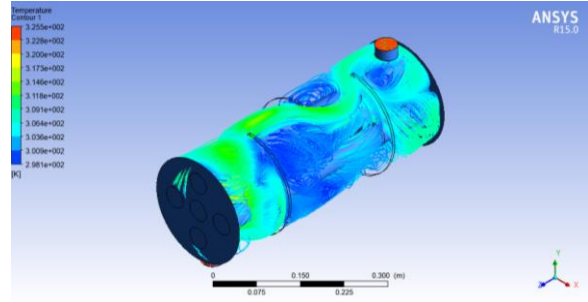

Figure 4.26 (a) Temperature distribution for Hot water outlet and cold-water inlet temperature.

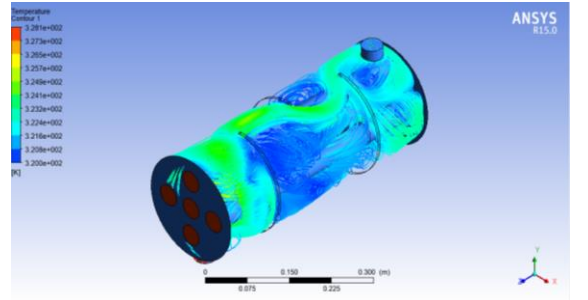

Figure 4.26 (b) Temperature distribution for Hot water inlet and cold-water outlet temperature.

4.3 Results for Triangular Pattern Tube Arrangement

4.3.1 Hot Fluid Inlet Temperature 348K for Triangular Pattern Tube Arrangement

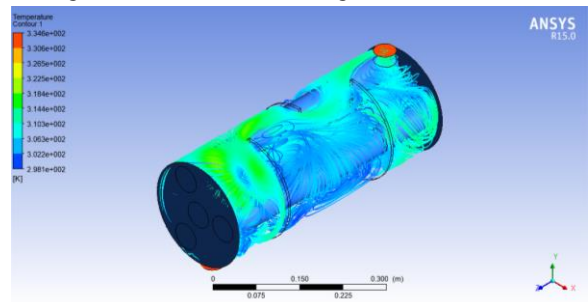

Figure 4.31 (a) Temperature distribution for Hot water outlet and cold-water inlet temperature.

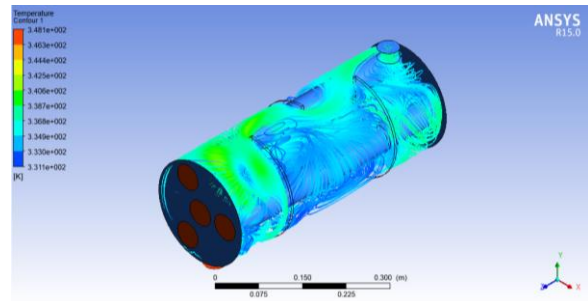

Figure 4.31 (b) Temperature distribution for Hot water inlet and cold-water outlet temperature.

4.3.2 Hot Fluid Inlet Temperature 338K for Triangular Pattern Tube Arrangement

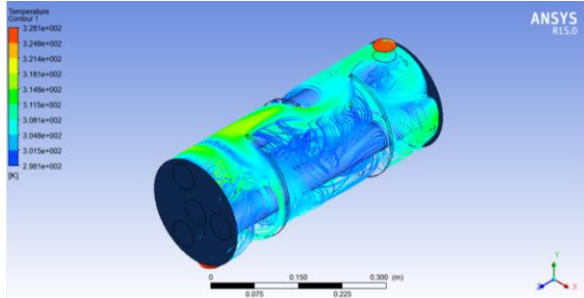

Figure 4.36 (a) Temperature distribution for Hot water outlet and cold-water inlet temperature.

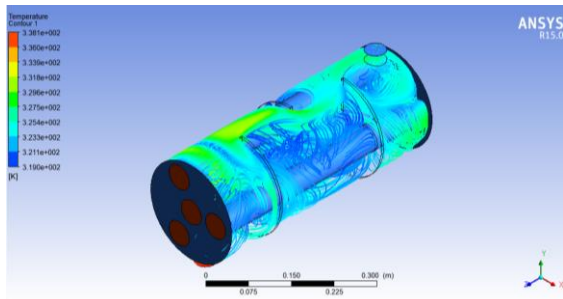

Figure 4.36 (b) Temperature distribution for Hot water inlet and cold-water outlet temperature.

#### V-CONCLUSION AND FUTURE SCOPE

The three different tube arrangements have been checked on the basis of Pressure drop, temperature difference, heat transfer coefficient, heat flux using LMTD analysis for the shell and tube heat exchanger. The following conclusion have been made:

1. At low fluid inlet temperature, the pressure drop shows a big difference among the three patterns. Its value is maximum for Triangular Pattern and minimum for Square pattern tube. The pressure drop is minimum for square pattern tube heat exchanger.
2. The overall heat transfer coefficient is higher for rotated square pattern design in all the three different hot fluid inlet temperature.
3. The turbulent kinetic energy is maximum for the square pattern tube arrangement helps to create a turbulence flow of a fluid which in turn increases the heat transfer efficiency.

#### REFERENCES

[1] Ahmad Fakheri, “Heat Exchanger Efficiency”, and Article in Journal of Heat Transfer · September 2007, DOI: 10.1115/1.2739620

[2] Ahmad Fakheri, “Arithmetic Mean Temperature Difference and the Concept of Heat Exchanger Efficiency”, Proceedings of HT2003, ASME Summer Heat Transfer Conference, July 21-23, 2003, Las Vegas, Nevada, USA

[3] Ahmed A. Maraie, Ali Ahmed M. Hassan, Mohamed Salah Hassan, Taha Ebrahim M. Farrag and Mamdouh M. Nassar, “An Investigation of Heat Transfer for Two-Phase Flow (Air-Water) in Shell and Tubes Heat Exchanger” International Journal of Innovative Research in Science, Engineering and Technology, 2016

[4] Arjun K.S. and Gopu K.B., “Design of Shell and Tube Heat Exchanger Using Computational Fluid Dynamics Tools” 2014, Research Journal of Engineering Sciences, ISSN 2278 – 9472 Vol. 3(7), 8-16, July (2014) Res. J. Engineering Sci.

[5] Ashkan Alimoradi, Farzad Veysi, “Optimal and critical values of geometrical parameters of shell and helically coiled tube heat exchangers”, Case Studies in Thermal Engineering 10 (2017) 73–78

[6] Dawit Bogale, “Design and Development of Shell and Tube Heat Exchanger for Harar Brewery Company Pasteurizer Application (Mechanical and Thermal Design)” 2014, American Journal of Engineering Research (AJER) e-ISSN: 2320-0847 p-ISSN: 2320-0936 Volume-03, Issue-10, pp-99-109

[7] J. Fernández-Seara, F. J. Uhía, J. Sieres, and A. Campo, "A general review of the Wilson plot method and its modifications to determine convection coefficients in heat exchange devices," Applied Thermal Engineering, vol. 27, pp. 2745-2757, 12// 2007.

[8] M. Thirumarimurugan, T.Kannadasan and E.Ramasamy, “Performance Analysis of Shell and Tube Heat Exchanger Using Miscible System” American Journal of Applied Sciences 5 (5): 548-552, 2008 ISSN 1546-9239

[9] Mir Majid Etghani, Seyed Amir Hosseini Baboli “Numerical investigation and optimization of heat transfer and exergy loss in shell and helical tube heat exchanger” 2017, Applied Thermal Engineering (2017)