

Arduino Based Color Detection for Visual Impaired

Bindu S Pagad¹, Namratha D Gaddad², Asst. Prof. Chaitanya K Jambotkar³

^{1,2} 6th SEM Student in Department of Electrical and Electronics Engineering, K.L.E.I.T, Hubli, Karnataka, India

³Assistant Professor in Department of Electrical and Electronics Engineering, K.L.E.I.T, Hubli, Karnataka, India

Abstract- Blindness is the condition of poor visual perception, estimation from World Health Organization state that 285 million people are visually impaired worldwide, 39 million are blind and 246 million have low vision. A Blind person with proper training can function like any person with perfect vision, but there are the small things that can improve the quality of a blind person life, like color detection which is the focus of this project. Being able to detect color can help in many ways, like identifying colors of clothes or even identifying uniquely colored objects (e.g. paper money) and appreciating art. The project will help overcome challenges that visually impaired people face in daily basis, by creating a way to detect colors and providing unique biofeedback for each color. The proposed embedded system imbibes Arduino microcontroller which reads the RGB data from the color sensor TCS230 which when processed further classify the color based on the lookup table programmed within the controller. The color so identified is displayed along with the RGB combination and also audio feedback of the color identified is given using DF player interfaced with Arduino. During the testing the embedded system the success rate of identification of colors was found to be 93%.

Index Terms- Arduino, Color detection, TCS230, DF player.

I. INTRODUCTION

Vision is the most important part of human physiology as 83% of information human being gets from the environment is via sight. The count of visually impaired people rises every year. The 2011 statistics by the World Health Organization (WHO) estimates that there are 285 billion people in world with visual impairment, 39 billion of which are blind and 246 with low vision [1].

In [2], The system presents a concept to provide a smart electronic aid for blind people, both in public and private space. The system is intended to provide

overall measures artificial vision and object detection, real time assistance via global positioning system (GPS). The microcontroller used is PIC microcontroller. The microcontroller circuit is on the outside of the stick but is protected with a code so its security cannot be breached. The only feedback given to the user is through the vibration motor.

In [3], three sensors are used viz. In [4], the stick has a ping sonar sensor to sense the distant objects. It also has a wet detector to detect the water. The microcontroller used is PIC microcontroller. Along with the developing technology, the use of devices such as Arduino is rapidly spreading. The simplicity of Arduino programming makes it more cost-effective to use it with a lot of additional parts. Arduino can be used not only for those with high level programming skills, but also for people of all age groups and those with any level programming knowledge. According to 2012 data, 1,559,222 people in Turkey have various obstacles due to various reasons. Approximately 213,077 people in our country have blindness. This corresponds to 14% of persons with general disabilities [5]. This rate is 284 million worldwide. 80% of the hindrances are treatable or preventable [6]. The paper Sensor assisted stick for the blind people describes about a wearable equipment which consists of a light weight blind stick and the obstacle detection circuit is based on a sensor.

In the paper[8] Obstacle Detection and location finding For Blind People the author describes a device which is used for guiding the person who is blind or partially sighted. The biggest problem of visually impaired people today is finding the roads and directions in the streets. Measures are taken with the yellow embossed roads that the municipalities apply to the paving stones. However, this method is often insufficient. In the paper [9] multitasking stick

for indicating safe path to visually disable people it describes a micro-controller based automated hardware that allows a blind to detect obstacles in front of her or him. The paper [10] ultrasonic blind walking stick describes an innovative stick which is designed for the visually disabled people for their easy navigation.

This study aims to make it easier to follow the yellow path on the ground with the color detection sensor in order to find the roads of visually impaired people more comfortable.

II. PROBLEM STATEMENT

The problem that the project focuses on is the inability to detect or distinguish between colors. This project conducted to help solve the problem by providing an alternative way to detect colors to help visually impaired person in his daily life.

III. MOTIVATION

The motivation behind making this project is to make the life of people easier as much as possible, to solve the complex problems of this world through which we can make this globe a better place for living. This world is full of colors which drive me to make a setup which can tell someone about the color of a particular thing. So this is the driving force which makes this imagination turning into reality.

IV. LITERATURE SURVEY

Akriti Kaushik, Aastha Sharama [1] explained that Sensor provide a means for gathering information on manufacturing operations and processes being performed. In a lot of instances sensors are used to transform a physical stimulus into an electrical signal that may be analyzed by the manufacturing system and used for making decisions about the operations being conducted. The purpose of sensors is to inspect work in progress, to observe the work-in-progress edge with the manufacturing utensils, and to permit self monitoring of manufacturing by the manufacturing system's own computer. Color sensors register stuff by contrast, true color, or clear index. True color sensors are based on one of the color models, most commonly the RGB model (red, green, blue). A large percentage of the visible spectrum can

be created using these three primary colors. Many color sensors are able to sense more than one color for multiple color sorting applications. Depending on the difficulty of the sensor, it can be programmed to know only one color, or multiple color types or shades for categorization operations. Through this report, the color detection, the basic color theory and the applications of color sensor will be review. In this report will be focusing on the application of color sensor using conveyor system.

Tushar G. Gaikar , Soham N. Zadokar, Rajendra S. Bhandari, Sagar S. Patil[2] described that the primary reason for the framework is to separate the item as for their shading code a naturally circulate the item as per their hues. In this anticipate we will distinguish the shade of the item which is put on transport line you need and that question is dispatch to separate box. This can be accomplished effectively by utilizing headway as a part of innovation particularly in the field of inserted frameworks. Presently a day's such a large number of helpful innovations are turning out to make our way of life more solace, extravagant and secure. In this anticipate we are utilizing Arduino (controller) and shading sensor. This shading sensor distinguishes shading and gives serial yield of RBG worth. It can distinguish 16.7 million shading shades giving RGB esteem for the recognized shading. The distinguished shading is recognized as measure of three essential shading values to be specific Red, Green and Blue with 8 bit exactness for every essential shading. Any shading can be isolated or consolidated into three essential hues Red, Green and Blue utilizing the RBG values.

Mingwei Liu[3] explained that a robot which can follow a black line on a white platform. This can be implemented by using 8 photo resistors array. First, these sensors are set to be output. After delaying for a period of time and setting ports input again, this array will receive light from surroundings and transfers it into digital signal. Since black and white has different reflection coefficient, the robot can use this to distinguish whether it's on a line or not. The delay time is an important parameter because it can determine the sensitivity of the sensor. After experiment several times, I found 200us is the perfect delay time for my robot. Besides tracking the black line, the robot can also detect colors of an object. This can be achieved by using a distance IR sensor and a RGB color detection sensor. The IR sensor can

calculate the distance of an obstacle in front. The robot can stop at certain point and use RGB color sensor to read from it. IR sensor can be easily used through ADC port. However, RGB color sensor has to use TWI communication protocol to obtain color because the color sensor contains much more information than IR sensor. For actuation part, at first I used two gear motors and a dual motor driver to control it. However, after changing the platform of my robot, I found the motors were not powerful enough so I replaced them with two servos. The robot and patrol on the map, going through every routine. When it detects object it will distinguish whether this object is red or blue. If the line ends, it will turn around and move on. The destination is a white area. The robot can go back after reaching the destination. Abhishek Kondhare, Garima Singh, Neha Hiralkar, M.S.Vanjale [4] explained that the project is a smart approach for a real time inspection and selection of objects in continuous flow. Image processing in today's world grabs massive attentions as it leads to possibilities of broaden application in many fields of high technology. The real challenge is how to improve existing sorting system in the modular processing system which consists of four integrated stations of identification, processing, selection and sorting with a new image processing feature. Existing sorting method uses a set of inductive, capacitive and optical sensors which do differentiate object color. This project presents a mechatronics color sorting system solution with the application of image processing. Image processing procedure senses the objects in an image captured in real-time by a webcam and is classified using a decisional algorithm and selected in real time. This information is processed by image processing for pick-and-place mechanism. This project uses an automated material handling system which is widely used in industries. M.Anil Kumar, Dr. S. A. K. Jilani, Mr. U. Sreenivasulu, Mr. S. Javeed Hussain [5] explained that color plays a vital role in human daily life for recognition. The main objective is to develop a prototype which can detect different colors for visually challenged people. They are expected to be interested in the color of their clothes, the color of toys and the color of pictures etc. This system helps the visually challenged peoples to recognize the colors without the help of third person, so they can identify the colors independently. This system is

implemented on Arduino microcontroller with android device in which color Recognition can be done. After Recognition there will be text to speech conversion so user or visually challenged person can get message from the Android device with the help of Mobile Speaker. The project is based on both hardware and software. This project uses Bluetooth Module that connects the hardware with a Mobile device. The software used in the project is Arduino IDE which is used for coding and as an interface between Arduino microcontroller and Mobile App. This model includes Mobile App with the hardware components such as Arduino microcontroller, Color Sensor, and Bluetooth Module. Arduino microcontroller toolbox are used to implement this project. The proposed system works in standalone mode without the necessity of PC if once programmed. We used the rapid prototype technique approach of a color object for real-time applications using Arduino support package meant for Arduino microcontroller. The use of arduino for color sensing is modeled as it provides a far more reliable, efficient, easy and quick method than the typical conventional sensing methods such as an RGBW MATRIX method and CYGM method which are described below A, RGBW MATRIX: An RGBW matrix (from Red, Green, Blue, White) is a CFA that includes "white" or transparent filter elements that allow the photodiode to respond to all colors of light; that is, some cells are "panchromatic", and more of the light is detected, rather than absorbed, compared to the Bayer matrix B, CYGM MATRIX:A CYGM matrix (Cyan, Yellow, Green, Magenta) is a CFA that uses mostly secondary colors, again to allow more of the incident light to be detected rather than absorbed. Other variants include CMY and CMYK matrices. Here we have modeled basic sensor limiting to only few colors but the models potential can be increased as per desire and requirement which also depends upon the use of the sensor or the corresponding application in a device such as display color adjustment, backlight dimmers in liquid crystal displays, and environmental color temperature detection, Brick sorter, Avoids separation of products in manufacturing industries.

V. METHODOLOGY

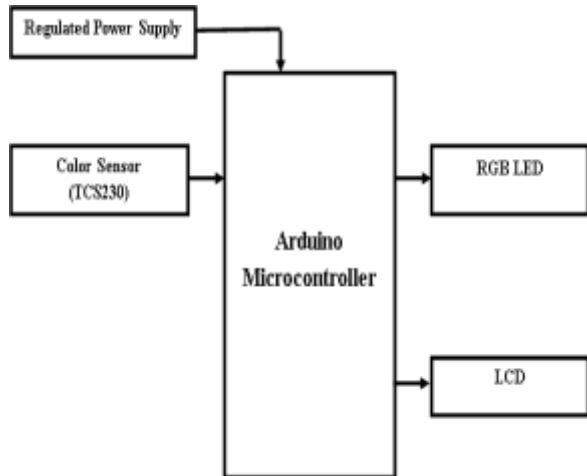

Fig. 1 Block diagram of the proposed concept

In this project we are going to interface TCS230 color sensor with Arduino UNO. TCS230 is a color sensor which can detect any number of colors with right programming. TCS230 contains RGB (Red Green Blue) arrays. As shown in figure on microscopic level one can see the square boxes inside the eye on sensor. These square boxes are arrays of RGB matrix. Each of these boxes contain Three sensors, One is for sensing RED light intensity, One is for sensing GREEN light intensity and the last in for sensing BLUE light intensity. Brain of the circuit is Arduino Uno R3 board having ATmega328 or ATmega328P microcontroller (MCU). It has 14 digital input/output (I/O) pins and six analogue input pins, 32k flash memory, 16MHz crystal oscillator, USB connection, power jack, ICSP header and reset button. Working of the project is simple because this is a basic circuit for interfacing a TCS230 sensor. When red color is kept near the sensor, it automatically detects the color with the help of photodiode arrays and then RGB color intensity value is displayed in Arduino serial monitor window along with color name. At the same time, a red LED glows in the RGB LED. Similarly, the remaining two colors (green and blue) are shown in Arduino serial monitor window and the respective color LED glows in RGB LED.

VI. HARDWARE IMPLEMENTATION

The following shows step wise implementation of the concept.

A. LCD interfaced with Arduino

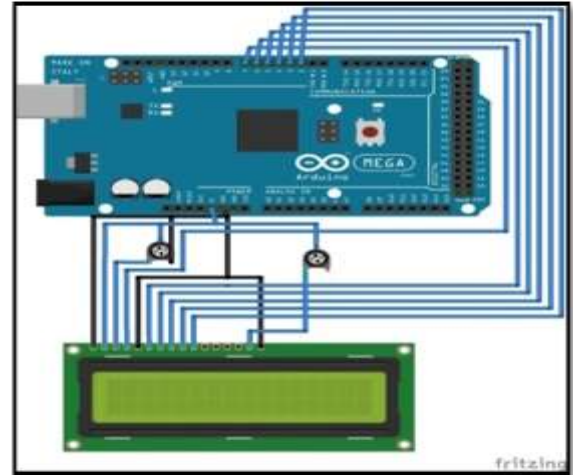

Fig. 2 Hardware implementation of LCD

The fig 2 represents circuit of LCD (20x4) interfaced with Arduino MEGA. The two potentiometer are used in order to control the contrast and brightness of the LCD. The LCD is used to display alphanumeric character. Four bit of data transmission is used to interface between the Arduino and LCD. Only write operation is used by sending a low signal to read/write terminal of the LCD.

B. DF Player interfaced with Arduino

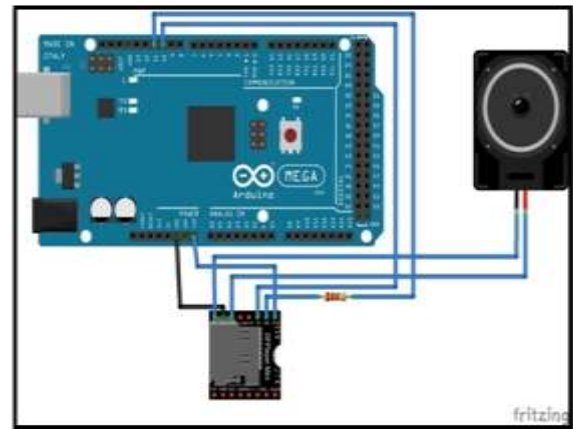

Fig. 3 Hardware implementation of DF Player

The fig 3 represents circuit of DF Player interfaced with Arduino MEGA. The DF Player Mini is a small and low cost MP3 module player with an simplified output directly to the speaker. The module is used as a standalone module with attached battery, speaker and with an Arduino . The DF Player perfectly integrates hard decoding module, which supports common audio formats such as MP3, WAV and WMA. Besides, it also supports TF card with FAT16, FAT32 file system.

C. TCS230 interfaced with Arduino

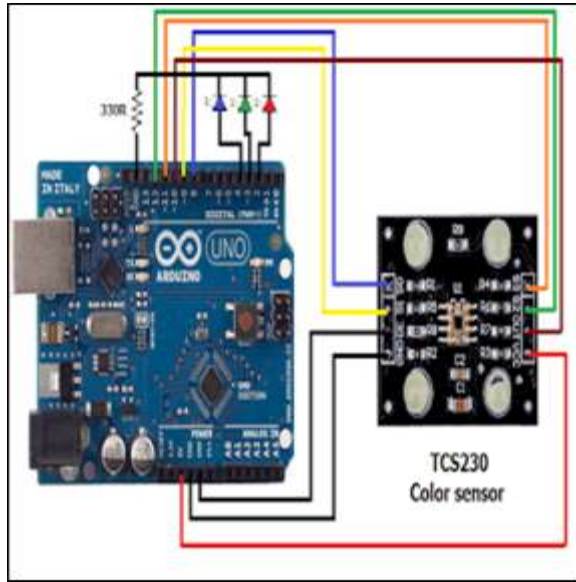

Fig. 4 Arduino interface with TCS230 color sensor
The above figure 4 depicts the interface of Arduino with the TCS230 color sensor and an RGB LED to identify the color detected.

VII. SOFTWARE IMPLEMENTATION

- Set the baud rate as 9600 for serial communication.
- Include the LCD.h header file in the sketch.
- Define GPIO pins interfaced with the Arduino
- Read the value from color sensors pin interfaced with the Arduino (frequency of light) namely S0,S1,S2, S3 and output.
- Map the read value with the lookup table in the algorithm to identify various colors using the interface.
- Display the identified colors on LCD interfaced with Arduino.
- Continuously monitor the color sensor and repeat the process as defined above.

VIII. RESULTS

The following illustrates the RGB values for Red, Blue and Green colors tested on the defined algorithm. It is found that with several iterations performed the accuracy of detection is approximately 93%.

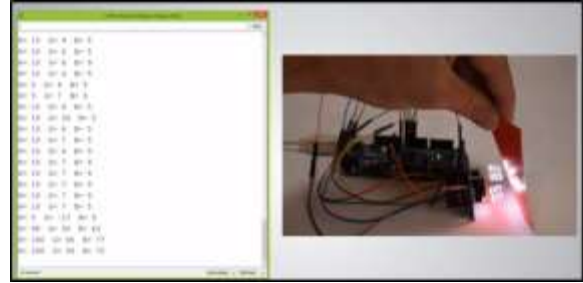

Fig. 5 Red color detection

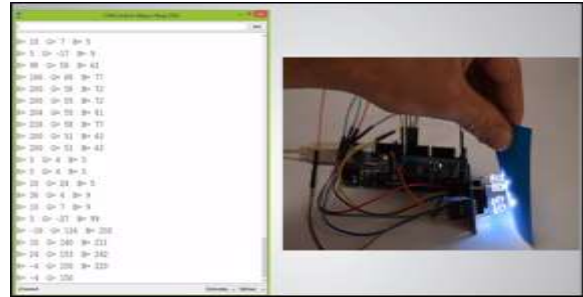

Fig. 6 Blue color detection

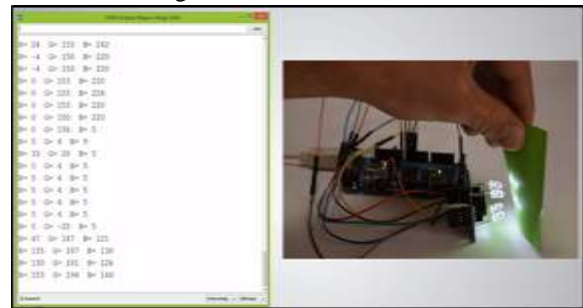

Fig. 7 Green Color detection

CONCLUSION

A cost effective, user friendly color detection embedded system is implemented successfully whose accuracy of detection is found to be 93%. The embedded system is expected to assist the visual impaired in color detection which in future will be improvised for object detection with audio feedback.

REFERENCES

[1] Akriti Kaushik, Aastha Sharama, "Rgb Color Sensing Technique" International Journal Of Advance Research In Science And Engineering <http://www.ijarse.com> IJARSE, Vol. No.2, Issue No.9, September 2013 ISSN-2319-8354(E)

[2] Tushar G. Gaikar , Soham N. Zadokar, Rajendra S. Bhandari, Sagar S. Patil," Object Sorting using Color Sensor and Arduino" International Journal on Recent and Innovation Trends in

Computing and Communication ISSN: 2321-8169 Volume: 4 Issue: 4 483 - 486

- [3] Mingwei Liu,"EEL5666 Intelligent Machine Design
Lab"https://mil.ufl.edu/5666/papers/IMDL_Report_Spring_11/Final%20Reports/Mingwei_Liu/Mingwei_Liu.pdf
- [4] Abhishek Kondhare,Garima Singh,Neha Hiralkar,M.S.Vanjale," Colour And Shape Based Object Sorting" International Journal Of Scientific Research And Education ||Volume||2||Issue|| 3 ||Pages|553-562||2014|| ISSN (e): 2321-7545
- [5] M.Anil Kumar, Dr. S. A. K. Jilani, Mr. U.Sreenivasulu M.Tech, (Ph.D.), Mr. S. Javeed Hussain," Automated Color Recognition System for Visually Challenged and Achromatopsia People using Arduino and Mobile App" ISSN: 2278 – 909X International Journal of Advanced Research in Electronics and Communication Engineering (IJARECE) Volume 4, Issue 8, August 2015.