

Design and Development of Intelligent Train Engine System for Real Time Applications

G. Krishna Veni¹, G. Srinivasa Rao², MD. Sheema Arjaman³, P. Anjalee Priya⁴, B. Lasya⁵, K. Surekha⁶

¹Asst. Professor, Bapatla Women's Engineering College, Bapatla

²Professor, Bapatla Women's Engineering College, Bapatla

^{3,4,5,6}UG Student, Bapatla Women's Engineering College, Bapatla

Abstract—Railroads offer many benefits to people, such as easy access to places, cheap travel, etc. In recent years, Indian Railways had many accidents due to railway breaks and many other mishaps. Therefore, there is a need to have new technology which will be robust, efficient and stable for both crack detection on railway tracks as well as fire detection. This project discusses Railway track crack detection. It is a novel method that detects the crack using red light which gives an alert to the station and the engine motor will be set off thus saving the lives of people. In this project we used Arduino Microcontrollers to control and manage the activities of this device and also designed a robust monitoring system to detect fire in compartments. Thus, water will be sprinkled using a water motor and an alert is given in the form of buzzer and red light such that the engine motor is set off and people will get off the train.

Keywords—Arduino UNO, Buzzer, Red light, Fire Sensor, Track, LCD.

I. INTRODUCTION

The railway has become one of the most important means of transport. Millions of people travel by train every day. A very important element of the railway is the signaling system, the correct functioning of which is essential for safe and reliable travel [4]. We know that Indian railways is the largest network in South Asia and perhaps the most complex in the world [4]. The Indian railway network today has the longest route length of 113,617 kilometers on a route of 63,974 kilometers and ,7083 stations [6]. In India, traveling by train is very profitable, but there are several train accidents every year. The path is straight and 20 feet long [4]. Many trains derail every year due to rail defects, such as incorrect positioning of contact pins or holes in the tracks, which lead to train derailments. Therefore, the contact strip, the use of bolts and the regular monitoring of the tracks serve as a safety measure to avoid an accident on the railway.

There are still many tracks in the country, including overlays and sleepers, but they are being replaced by track tracking. And therefore, the presence of cracks in the rails is the main cause of derailments. The lives of rail passengers are endangered by mishaps such as derailment cracks, railway operations are sometimes the cause of train collisions and compartment fires. The figure below shows a crack in the railroad.

Therefore, in order to prevent railway accidents, it is important to detect track monitoring failures and detect compartment fires through seamless integration of detection devices [1]. Existing technology uses ultrasonic sensors to detect cracks. This has the disadvantage that multiple sensors are used. Therefore, to overcome this disadvantage of material complexity, we have proposed a new crack detection technique in this article. Here, instead of using an ultrasonic sensor to detect cracks, we use open and closed joints to detect cracks at different distances. A given range of distances (i.e., between two stations) is considered when a given amount of power is applied at one end when at the other end (i.e., say, continues) there is no gap between the two stations. When the voltage drops to zero, the system detects a pause between these stations and beeps. And he will alert the authorities. As an extension, we use a fire detector to detect fires in train compartments.



Fig. 1. Crack on Railway Track

In this paper, we present an automated system for providing warning notices for potentially unsafe conditions ahead [5], based on a microcontroller which is one of the major devices in the field of electronics [3], open and closed circuits to overcome the problem of faults in tracks and we used fire sensors to detect fire and thus reduces fire accidents. It is mostly useful for human life and decreasing the ratio of accidents due to cracks. In section II explanation about the methodology, in section-III brief description about circuit implementation, in section-IV and section-V the results and conclusion are included.

II. METHODOLOGY

The cracks on railway tracks are the main cause for rail accidents which is to be considered as a serious issue. In this project we have implemented a new technique. For crack detection in which instead of using ultrasonic sensors we are using open and close circuit method. As ultrasonic sensor has the drawback of using a greater number of sensors which make it complex and has a risk destroying the connection of sensors. For this reason, we have come up with a new technique for crack detection.

As discussed above for this crack detection technique we had used Arduino, power supply, crystal oscillator, fire sensor, buzzer, red light in which Arduino micro controller control the entire system since all components are connected to the Arduino board.

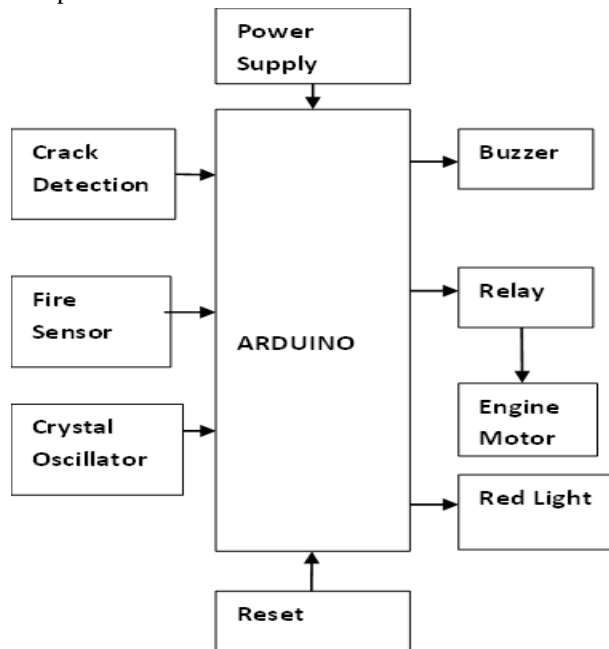

Fig. 2. Block Diagram

A. Crack Detection

The 5v of power supply is applied to the railway track at one station and it is made to pass through the track to next station. If the 0v supply is received at the receiver station then it is concluded that there is a crack between those two stations. Then manually we will check and rectify the crack. Crystal oscillator generates clock signals which are passed through the railway track to detect the crack and gives a buzzer then automatically red light is set on. And engine will be off which is optional.

B. Fire Detection

when fire sensor activates then buzzer indication will be obtained thus save the lives of the passengers. A sensor network performs detection and communication [2]. In this fire sensing process engine is not set off due to the reason that fire sensor senses even a little fire and it leads to a false sense for this we are using relay. We use IR sensor receiver part for detecting the fire. Here fire is detected on the basis of observation but it doesn't sense the temperature. Arduino software is an open source makes it easy to write the code and upload it to the board, this software can be used in any Arduino board.

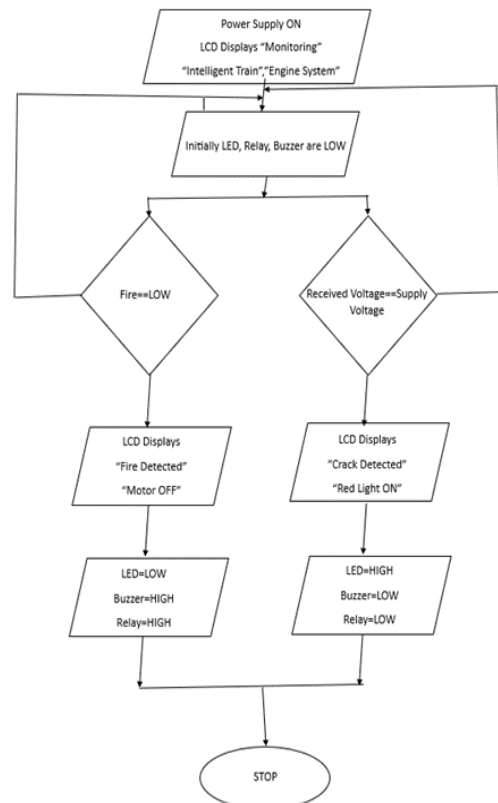

Fig. 3. Flow Chart

III. CIRCUIT IMPLEMENTATION

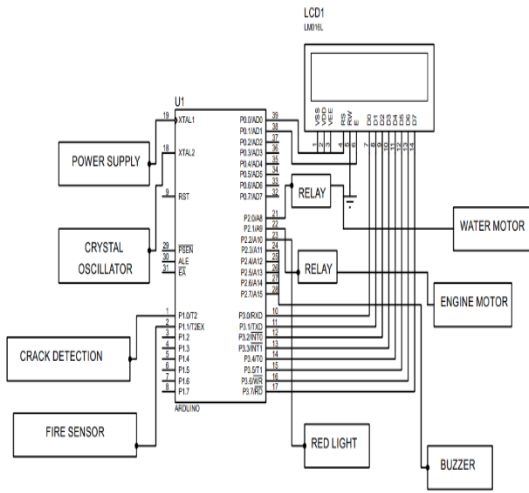

Fig. 4. Schematic Diagram of Crack Detection System

For railroad track crack detection, we designed a circuit using Arduino, power supply, crystal oscillator, crack detector, fire sensor, red light, buzzer, motor, pump motor water, a relay and an LCD screen. Arduino UNO is a microcontroller board based on ATMEGA 328 [6]. It has 14 digital input and output pins (6 of which can be used as PWM outputs). Six analog inputs and programmable with the Arduino IDE [6]., 16MHz ceramic resonator, USB connector, power connector, ICSP connector and reset button. It simply connects to your computer with a USB cable or is powered by AC and DC adapters and batteries to get you started. UNO differs from all previous boards in that it does not use the FTDI USB-to-Serial driver chip. Instead, it contains an ATMEGA 16U2 chip programmed as a USB-to-serial converter. The crystal oscillator is mainly used in digital integrated circuits to provide a stable clock signal and in some applications that require a high reference frequency. The Arduino Uno can be powered by the via USB or via an external power supply. The power source is automatically selected. External power (other than USB) can come from an AC-DC adapter (wall outlet) or from batteries. You can connect the adapter by inserting the center positive 2.1mm connector into the power jack on the card. The battery cables can be connected to the Gnd and Vin pins of the power connector.



Fig. 5. Arduino UNO

Board may be unstable if using more than 12V, the voltage regulator may overheat and damage the board. The recommended range is 7 to 12 volts.

A DC power supply unit deriving power from the main supply performs a number of tasks include, it changes the level of supply to a value suitable for driving the load circuit, produces a DC supply from a pure AC wave, prevent any AC from applying at the supply output. Two power supply modules which consist of a Bridge rectifier, Voltage regulator, and capacitor are considered. It will ensure that the output voltage kept at a constant level. A Rectifier is an electrical device that converts alternating current which periodically reverses direction to direct current which flows in one direction which is called rectification.

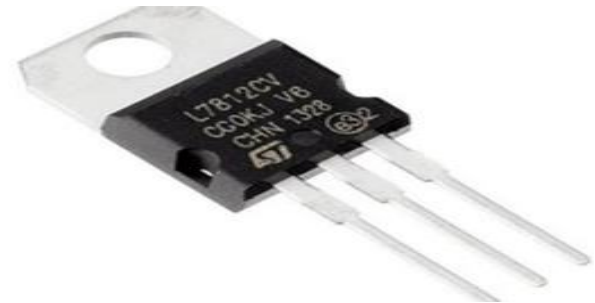

Fig. 6. 7812 Regulator

A circuit used to produce constant DC output voltage by reducing the ripple to negligible amount is called regulator. A voltage regulator is a system designed automatically maintain a constant voltage level.

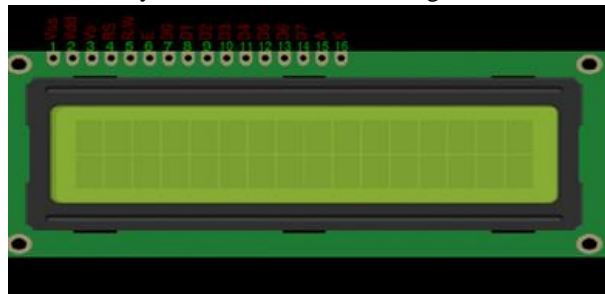

Fig. 7. LCD Display

The LCD display is used to display the content and output of the system and the brightness of the display is controlled by using variable resistor. Buzzer is used to give an alert to the authorities and passengers as well.

A buzzer or beeper is an audio signalling device which may be mechanical or electromechanical.



Fig. 8. A Buzzer



Fig. 9. Red Light

LEDs are used in all commercial systems today due to their extremely low cost and the fact that most LEDs emit light over a wide enough area to be considered safe for the eyes [7].

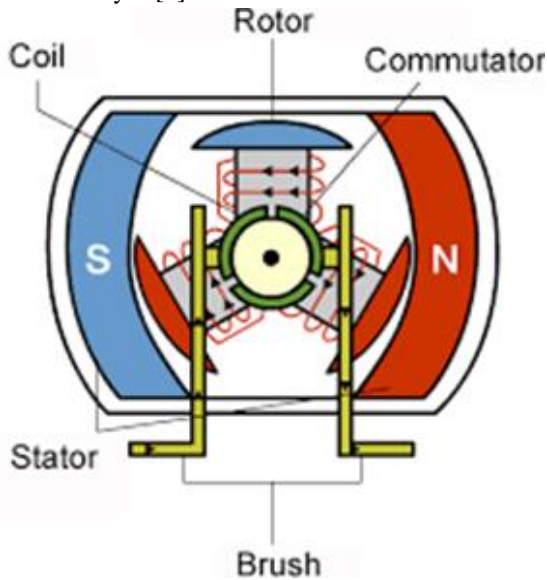

Fig. 10. DC Motor

The DC Motor is a DC powered electric motor. The operation of any electric motor is based on simple electromagnetism. Here, the DC motor represents the internal combustion engine that starts when a crack or fire is detected.

IV. RESULTS



Fig. 11. Prototype Model

The robust monitoring system that detects crack in railway tracks is shown in the following figure. Here crack in railway track is been represented as a copper wire which is provided with a cut in between which denote crack in railway tracks.

In this model connections are made as per our required output and power supply is given to the Arduino UNO using power jack. When the power supply is given the system is set ON and motor starts rotating, LCD displays “MONITORING “initially and then starts working. Arduino output pins are connected to buzzer, red light, Engine motor, Water pump. Based on condition corresponding output is displayed. In which Initial state of the track monitoring system is as shown in figure.



Fig. 12. Initial System with Power Supply

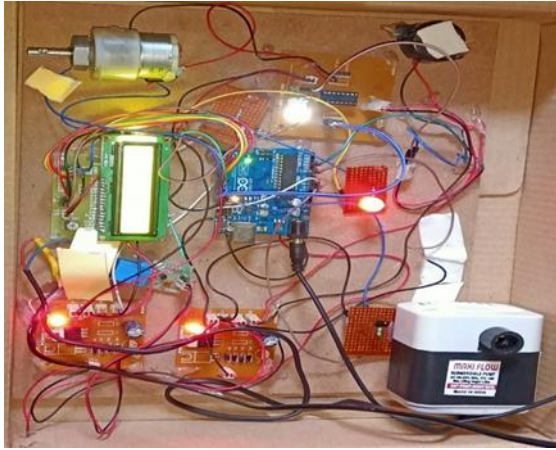

Fig. 13. Crack Detected

In the above figure the copper wire cut is set open which represents a crack in railway track. In this condition the LCD display “CRACK DETECTED” and red light, Buzzer are set ON, and Engine motor is OFF.

Similarly, when a fire is detected Engine motor is set OFF, Buzzer, Red light are set ON and water starts sprinkling using water motor, where water motor is submerged in water such that it applies hydraulic pressure and pulls out the water through a pipe.

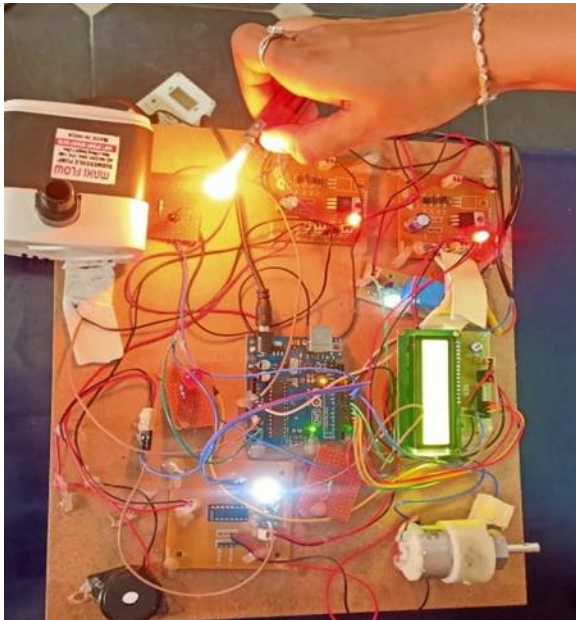

Fig. 14. Fire Detected

V. CONCLUSION

Railways are used by people everyday. Protection of people is very important so the latest crack detection monitoring system will be very helpful to save the lives of the people. The program proposed in this is firstly it

will check the crack by using open and close connections if the crack is detected the red light and buzzer will be given to give an alert for the authorities and also the fire sensor will be activated when the fire is absorbed and water will be sprinkled on the fire by using water motor. This would allow rail accidents caused by railway cracks to be avoided and thus save lives and ensure the safety of railways. For the future scope we can enhance this project by reducing the fire sensors.

ACKNOWLEDGMENT

The authors (MD. Sheema Arjaman, P. Anjalee Priya, B. Lasya ,K. Surekha) would like to sincerely thank G.Krishna Veni M.Tech (Ph.D), Electronics and Communication Engineering Department in Bapatla Women’s Engineering College for her valuable support and help in project.

REFERENCE

- [1] J. Guerrero- Ib anez, S. Zeadally, J. Contreras-Castillo, Sensor Technologies for~ Intelligent Transport Systems, Sensors 18 (4) 2018 1e24, <https://doi.org/10.3390/s18041212>.
- [2] S. Cheung, S. Coleri, B. Dundar, S. Ganesh, C.-W. Tan, P. Varaiya, Traffic measurement and vehicle classification with single magnetic sensor, Transport. Res. Rec.: Journal of the Transportation Research Board 1917 (January) (2005) 173e181, <https://doi.org/10.3141/1917-19>.
- [3] Sanjeev Kumar, Shweta Gupta, Dibyayan Das Sharma, “An Intelligent Train Engine Based on Auto-Signal Following Scheme Using IR Technology”, The IUP Journal of Electrical and Electronics Engineering, Vol. IV, No. 4, pp. 36-47, October 2011.
- [4] Anil Kumar Verma, Dharmendra Kumar, Gopal Krishna gole, Jitendra kumar, “Intelligent Train Engine for the Fastest New Age Technology”, International Journal of Innovative Research in Computer and Communication Engineering, vol. 1, Issue 1, March 2013.
- [5] J.-H. Dokko, Traffic condition displaying system (Patent No. 5,892,461), <https://patentimages.storage.googleapis.com/03/b7/a0/5eddd9975c52af/US5892461.pdf>, 1999.
- [6] N. L. Bhojwani, A. S. Ansari, S. S. Jirge, M. B. Baviskar, D. N. Pawar “Railway track-crack

detection system by using Arduino microcontroller ” International journal of engineering applied sciences and technology,2021.

- [7] J. M Khan and J. R Barry, “Wireless Infrared Communications”, Proceedings of the IEEE, Vol. 85, pp. 265, February 1997.
- [8] A. Dubey, Akshdeep, S. Rane, Implementation of an intelligent traffic control system and real time traffic statistics broadcasting, in: Proceedings of the International Conference on Electronics, Communication and Aerospace Technology, 2017, pp. 33e37, <https://doi.org/10.1109/ICECA.2017.8212827>. ICECA 2017, 2017-Janua.
- [9] Espressif, ESP8266 technical reference (issue february). www.espressif.com, 2019.
- [10] G. Feltrin, N. Popovic, M. Wojtera, A sentinel node for event-driven structural monitoring of road bridges using wireless sensor networks, Journal of Sensors 2019 (2019), <https://doi.org/10.1155/2019/8652527>.