

# Multi Input Modified Z Source Based Boost Converter Fed BLDC Motor for Electric Vehicle

Sri Vishnu Priya N<sup>1\*</sup>, Dr. Mahendren<sup>2</sup>, Senthilkumar T<sup>3</sup>

<sup>1</sup>ME Student, Department of Electrical and Electronics Engineering, Er. Perumal Manimekalai College of Engineering, Hosur-635117

<sup>2</sup>Associate Professor, Department of Electrical and Electronics Engineering, Er. Perumal Manimekalai College of Engineering, Hosur-635117

<sup>3</sup>Assistant Professor, Department of Electrical and Electronics Engineering, Er. Perumal Manimekalai College of Engineering, Hosur-635117

**Abstract-** For an electric car, this project proposes a multi-input modified Z source based boost converter fed BLDC motor. A MIZB is added to improve converter output for voltage stability. In order to raise the voltage level of the PV, a GA-based RBFNN MPPT is utilized to monitor the solar panel's maximum power. The bi-directional battery converter is connected with a solar panel as one of the input sources. The excess electricity from the PV array is provided into the EV motor to run it during the solar eclipse in addition to charging the battery. When it is dark and overcast outside, the battery power is activated and used as an extra input source to power the BLDC motor.

**Keywords:** MIZB - Multi-Input Modified Z Source-Based Boost Converter, BLDC - Brushless Direct Current, RBFNN - Radial Basis Function Network, PWM – Pulse Width Modulation, EV – Electric Vehicle. GA – Genetic Algorithm.

## 1. INTRODUCTION

Electric cars today have numerous electrical machinery that are efficiently managed and operated thanks to developments in power converter technology. Torque ripples are detrimental to the dynamics and stability of an electric vehicle. Because the battery voltage required for the motor to work is larger than the voltage of the individual cells, a series combination of many cells is required. However, battery management becomes more challenging and reliability degrades when numerous cells are wired in series. Applications for power converters with voltage-boosting capabilities are now being investigated as a consequence. For a single-phase application, the boost converter offered offers a solution, but it overlooks the three-phase application

[1-2]. By supplying fluctuating DC-Link voltage at a transitional period, the proposed Z-source converter evolved into a unique family of inverters capable of buck-boost operation for single-phase and three-phase applications. EVs consume far less fuel than gasoline-powered vehicles and don't have any exhaust emissions. They have a driving system that is far more maintenance-free, user-friendly, and silent. To promote the use of electric mobility, you should embrace environmentally friendly behaviors, and we should engage in more technical developments to hasten the spread of e-mobility-related research. EVs have been created and put into use in this environment to minimize reliance on fossil fuels, lowering emissions of greenhouse gases and other pollutants [3-4].

The name of BLDC motors makes it obvious that they are brushless. The rotor is equipped with permanent magnets, while the stator has coils that are wound with electromagnets. Electrical energy is converted into mechanical energy through the electrical commutation process. A DC brushless motor can be set up as an "Out runner" or an "In runner." In an in-runner motor, the rotor is positioned on the inside of the stator. The rotor is located outside of the stator in an out-runner motor [5]. The motor's stator is housed within, while the rotor is outside. It is sometimes referred to as a hub motor since the wheel is directly attached to the external rotor. An external gear system is not required to be used with this type of motor. The motor occasionally has planetary gears [6]. The main issue with a light car or a typical EV is charging. Inverter is a key component of this, and appropriate switching technique is needed for the system to operate more

effectively. Backup options for PV energy include battery storage or the grid. Along with EV charging, it is crucial to ensure grid power quality. Hybrid smart grid powered charging stations can decrease transmission losses, however uncoordinated EV charging with smart grid would result in poor use of renewable resources, hence a good energy management system is necessary to operate the proposed system successfully [7-8]. Overall, the development of a multi-input source EV necessitates careful planning and cooperation amongst several disciplines, including electrical engineering, mechanical engineering, and control systems engineering. However, the advantages, including longer range, more efficiency, and quicker charging periods, make it a potentially fruitful area for advancement in the field of electric vehicles. So to overcome some issues and increasing the efficiency of the proposed system, a new topology of the Z source boost converter is used, that was used to drive a BLDC motor and speed control [9-10]. The objective of the proposed system is to create a revolutionary single-output system that combines a bidirectional battery converter with a multi-input modified Z-source boost converter and to implement into practice an intelligent Genetic algorithm-based RBFNN algorithm for PV system power point tracking at its highest level also to develop and access potential solutions, genetic algorithms employ a random process.

## 2. PROPOSED SYSTEM EXPLANATION

The progress of EVs in the current era has made the development of EV charging infrastructure necessary. Plug-in Electric Vehicles typically employ three-phase off-board DC quick chargers for their propulsion systems. The converter's boost conversion capability enables the BLDC motor drive to use an economical motor controller and inverter switches during propulsion and regeneration operations by adjusting the dc bus voltage in line with driving conditions. As a result, the entire system is small, effective, and affordable, making it a good choice for an on-board charging system.

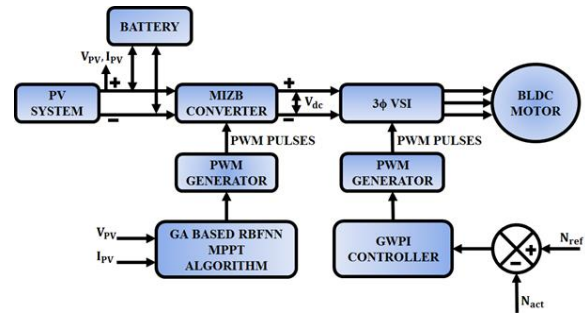

Fig.1. Proposed block diagram

A MIZB is recommended in this system proposal in order to supply the BLDC motor for usage in electric vehicle applications and to enhance converter output for voltage stability, a MIZB is shown in Fig.1. A GA-based RBFNN MPPT keeps track of the solar panels' maximum output in order to increase the voltage level of the PV. In order to get the converter to extract the highest output power from PVS under various situations, MPPT approach is applied. One of the input sources for the bi-directional battery converter is a solar panel. The PV array also powers the EV motor in addition to giving the battery extra energy during the height of the sun's light. The battery power is turned on and utilized as an additional input source to power the BLDC motor when it is cloudy and dark outdoors. The usefulness of an electric vehicle is enhanced by GWPI's management of the BLDC motor speed.

## 3. PROPOSED SYSTEM MODELLING

### 3.1 PV System

A semiconductor transistor that has been exposed to light is a solar cell. Few of the variously energetic particles in this solar output are caught at the p-n contact. In contrast to band gap, this sector employs the greatest energy rays. A single diode is utilized to construct comparable devices that are frequently used to represent PV cells, which offers a better balance between accuracy and usability. In Figure 2, the equivalent schematic is shown

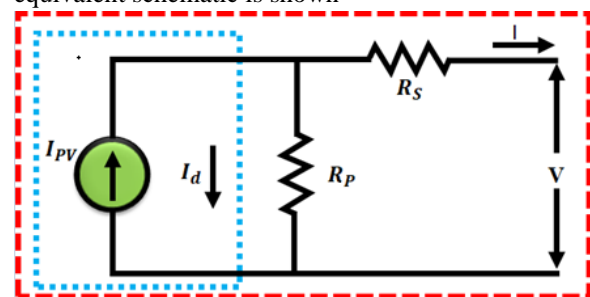

Fig. 2. PV System

The V-I characteristic equation is given by,

$$I_{out} = I_{Sh} - I_{sat} \left[ \exp \left( \frac{V_{out} + I_{out} \cdot R_s}{V_{th}} \right) - 1 \right] - \left( \frac{V_{out} + I_{out} \cdot R_s}{R_{sh}} \right) \quad (1)$$

Thus the showing of PV classification is achieved and from (1), the yield voltage and the input voltage are assessed.

### 3.2 MIZB converter

With a Z-source that has a strong step-up capability and minimal device voltage stress, it is advised to employ a boost converter. The proposed method connects input and output through a common media, which makes it more suited for certain applications. The voltage received from the PV system must be increased using a converter technique. A DC-DC converter is often used to boost the voltage the PV system produces. The High Gain Modified Z-source Boost converter, a more advanced boost converter, is implemented in this proposed work. The Z-source Boost converter may be switched on to stabilize the PV's nonlinear output.

### 3.3 PWM generator

An improved phase shift control of second stage converter is utilized to regulate the output during disturbances from the source side and a PWM control is used to regulate the DC link voltage. To produce the required AC voltage waveform, PWM signals are used to control the switches. The switches in the inverter are turned on and off at a high frequency, typically between several and tens of kHz, to produce the AC voltage waveform. The output of the solar PV system is maximized using a genetic algorithm-based MPPT, and the regulated output is then sent from the PWM generator to the switch current PWM signal.

### 3.4 GA based RBFNN MPPT Algorithm

The way an RBF network is designed, the hidden layer space is created by using RBF as the "basis" for the hidden layer units. When the RBF's central points are identified, the input vector may be immediately translated to the hidden space since it is a nonlinear function that is symmetrical on the central points and distributed locally.

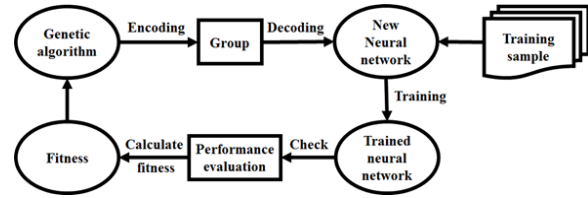

Fig.3. Flowchart of GA based RBF

It is an iterative process; in each iteration, a candidate solution is retained, sorted by solution quality, and then some of the answers are selected based on certain indicators and are computed using genetic operators to create a new generation of candidate solutions. We'll keep doing this till it reaches a certain convergence index. The definition of fitness function, the construction of genetic operators, and chromosomal coding are the essential components of the genetic algorithm used to optimize RBF network. With the help of the GA-RBF optimization algorithm, a neural network and a genetic algorithm may be combined naturally while automatically adjusting their network topology and connection weights without the need for human involvement is shown in Fig.3.

### 3.5 GWPI Controller

The command structures and hunting strategies utilized by grey wolves in their native habitat are substantially imitated by GWO. There are grey wolves named alpha, beta, delta, and omega in every pack. The three phases of their hunting strategy are similarly scouting, encircling, and attacking the target. Each of these procedures is finished concurrently with the optimization activity. It is easy to comprehend and put into effect because it is based on animals and nature. The key advantages of GWO are its adaptability, simplicity, and clarity.

## 4. RESULT AND DISCUSSION

The data that will be used for training are chosen using the MATLAB. The hardware view and the experimental analysis of MIZB in BLDC for EV are discussed below.

### 4.1 Hardware View



Fig.4. Hardware View

This Z-source boost converter for an EV is shown in Fig.4. This research proposes a multi-input modified Z source based boost converter feed fed BLDC motor for an electric vehicle. To enhance converter output for voltage stability in MIZB is given.

4.2 Experimental Analysis

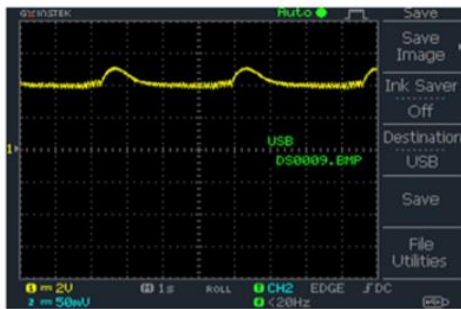

(a)



(b)

Fig.5. (a) Input DC voltage supply Waveform (b) Converter Output DC Voltage Waveform

provides a device with DC voltage. The DC voltage waveform of the converter is shown in (b). The converter generates a controlled output voltage  $V$  that differs from  $V_g$  in amplitude

The waveform of the input DC voltage is shown in (a). A DC power supply is a kind of power source that

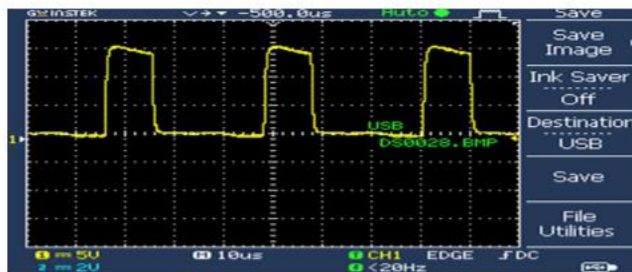

(a)

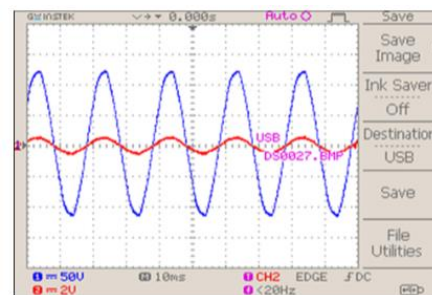

(b)

Fig.6. (a) Pulse Waveform for Converter (b) Grid Synchronization Output

The converter's pulse waveform is seen in (a). Pulse number is defined as the number of pulses in the dc output voltage within one time period of the ac source voltage and (b) represents that grid synchronization output. Synchronisation is the process of matching the frequency, phase, and voltage of a generator or other source to an electrical grid in order to transfer power in an AC electric power system. This

waveform demonstrates the phase alignment of current and voltage.

The assessment of the voltage gain values of the converters are listed in Fig.7, in which they are listed as 84%, 88.3% and 92.1% for Boost, Z source and MIZB respectively

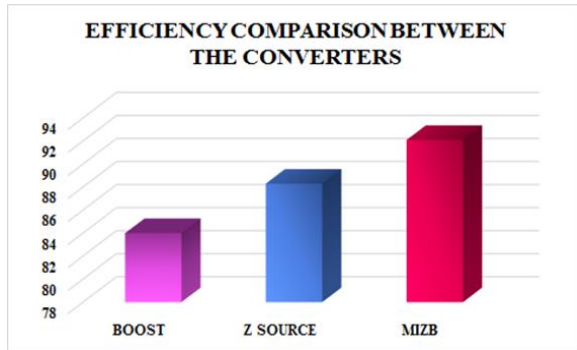

Fig.7. Efficiency Comparison

## 5. CONCLUSION

In this study, an electric vehicle-specific multi-input modified source with a boost converter-fed BLDC motor that is supplied by a Z-source is proposed. A solar panel and a battery supply the bulk of the energy to the energy management system that drives the EV motor. This proposed method, which employs a MIZB, is discussed for enhancing converter output for voltage stability. A genetic algorithm-based MPPT is used to optimize the solar PV system's output, and the regulated output is then sent from the PWM generator to the switch's current PWM signal. In this study the speed of the BLDC motor is controlled by a GWPI controller to ensure smooth operation.

## REFERENCE

- [1] Liu, P., and H. P. Liu. "Permanent-magnet synchronous motor drive system for electric vehicles using bidirectional Z-source inverter." *IET Electrical Systems in Transportation* 2, no. 4 (2019), pp: 178-185.
- [2] Aljafari, Belqasem, Gunapriya Devarajan, Selvi Arumugam, and Indragandhi Vairavasundaram. "Design and implementation of hybrid PV/battery-based improved single-ended primary-inductor converter-fed hybrid electric vehicle." *International Transactions on Electrical Energy Systems* 2022 (2022).
- [3] Ellabban, Omar, and Haitham Abu-Rub. "An overview for the Z-Source Converter in motor drive applications." *Renewable and Sustainable Energy Reviews* 61 (2019), pp: 537-555.
- [4] Mitra, Uliya, Anoop Arya, Sushma Gupta, and Ankur Kumar Gupta. "A brief overview on fuel cell electric vehicles." In 2022 *International Conference on Emerging Trends in Engineering and Medical Sciences (ICETEMS)*, pp. 124-129. IEEE, 2022.
- [5] Tripathi, P. R., V. Laxmi, R. K. Keshri, A. V. Jha, B. Appasani, N. Bizon, and P. Thounthong. "A Three-Phase Resonant Boost Inverter Fed Brushless DC Motor Drive for Electric Vehicles." *Electronics* 2021, 10, 1799." (2021).
- [6] Ramanathan, G., C. Bharatiraja, R. Saketh Srikar, and D. Surya Tej. "Implementation of modified Z-source inverter integrated for electric vehicle fast charging." *Materials Today: Proceedings* 65 (2022), pp: 265-270.
- [7] Schuss, Christian, Tapio Fabritius, Bernd Eichberger, and Timo Rahkonen. "Impacts on the output power of photovoltaics on top of electric and hybrid electric vehicles." *IEEE Transactions on Instrumentation and Measurement* 69, no. 5 (2019), pp: 2449-2458.
- [8] Mohanraj, Deepak, Ranjeev Arul David, Rajesh Verma, K. Sathiyasekar, Abdulwasa B. Barnawi, Bharatiraja Chokkalingam, and Lucian Mihet-Popa. "A review of BLDC Motor: State of Art, advanced control techniques, and applications." *IEEE Access* 10 (2022), pp: 54833-54869.
- [9] RAM, V. JANAKI, and A. PURNA CHANDRA RAO. "A Renewable Grid for Cascaded Multi Cell Z-Source Inverter with Boost Inversion for ASD Drives." (2017).
- [10] Zhang, Duo, Guohai Liu, Huawei Zhou, and Wenxiang Zhao. "Adaptive sliding mode fault-tolerant coordination control for four-wheel independently driven electric vehicles." *IEEE Transactions on Industrial Electronics* 65, no. 11 (2018), pp: 9090-9100.